



Quick Setup Guide

Pressure Washer

Have Questions?

Do not return to store. We can help.

Call Customer Service Toll-Free 1-800-743-4115

or visit our website, BRIGGSandSTRATTON.COM

WARNING Failure to read and follow the operator's manual and all operating instructions could result in death or serious injury.

WARNING Fuel and its vapors are extremely flammable and explosive which could cause burns, fire or explosion resulting in death or serious injury. Turn pressure washer engine OFF and let it cool at least 2 minutes before removing fuel cap. Let spilled fuel evaporate before starting engine. Always allow space for fuel expansion.

WARNING Starter cord kickback (rapid retraction) will pull hand and arm toward engine faster than you can let go which could cause broken bones, fractures, bruises, or sprains resulting in serious injury. NEVER pull starter cord without first relieving spray gun pressure. Pull starter cord slowly until resistance is felt, then pull rapidly. Firmly grasp spray gun with both hands when using high pressure spray to avoid injury when spray gun kicks back.

WARNING Engine exhaust contains carbon monoxide, a poisonous gas that could kill you in minutes. You CANNOT smell it, see it, or taste it. Operate ONLY outside far away from windows, doors and vents. Install carbon monoxide alarms. DO NOT run this product inside homes or garages, even if using fans or opening doors and windows.

WARNING High water pressure could cut through skin resulting in serious injury. Spray gun traps high water pressure, even when engine is stopped and water is disconnected. NEVER aim spray gun at people, animals, or plants. ALWAYS point spray gun in safe direction, press red button and squeeze spray gun trigger to release high pressure, every time you stop engine.

WARNING Risk of eye injury. Spray could splash back or propel objects resulting in serious injury. Always wear indirect vented (chemical splash) safety goggles marked to comply with ANSI Z87.1 when using or in vicinity of this equipment. NEVER substitute safety glasses or dry-condition goggles for indirect vented safety goggles.

Items Included: Operator's Manual, Oil Funnel & Two Keys (not shown)

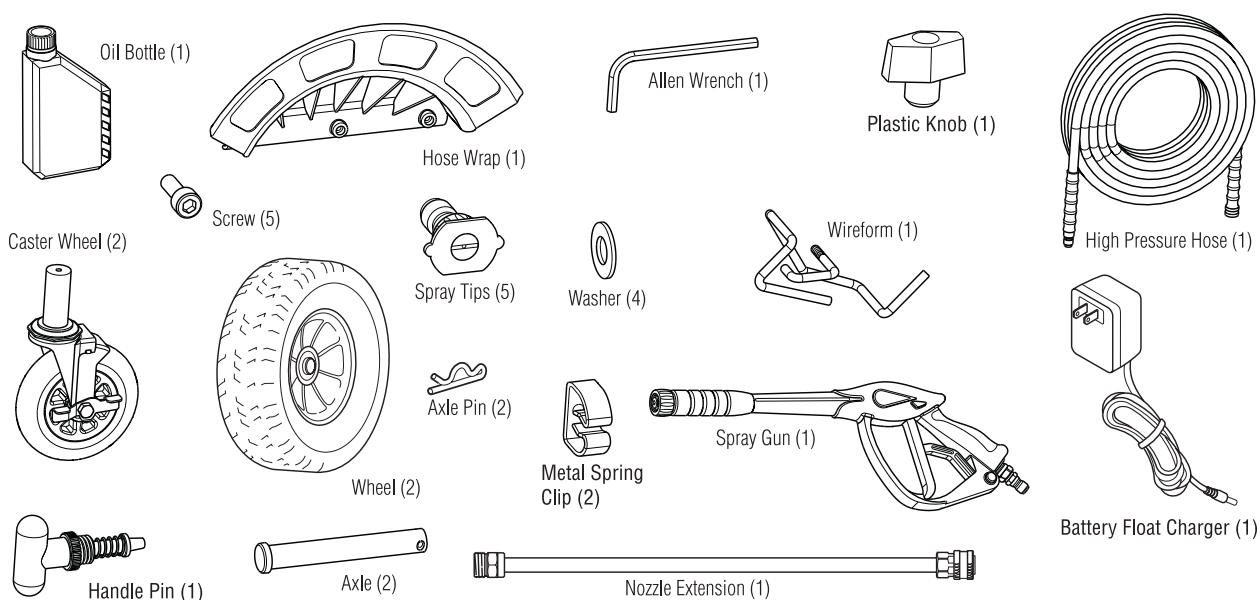

You will need:

- Utility knife
- Unleaded fuel
- 8 mm and 19 mm (3/4") wrenches
- Petroleum or synthetic grease
- Garden hose, 50 ft. (15 m) or less
- Safety goggles (indirect vented type)

Unpack pressure washer

1. Remove everything from carton except pressure washer.
2. Open carton completely by cutting each corner from top to bottom.
3. Ensure you have all included items prior to assembly. If items are damaged or missing, call **1-800-743-4115**.
4. Prior to assembly, lubricate the rubber o-ring seals on all connections with petroleum or synthetic grease. See Operator's Manual, *Lubricate O-Rings*. 13 14 15 17 18

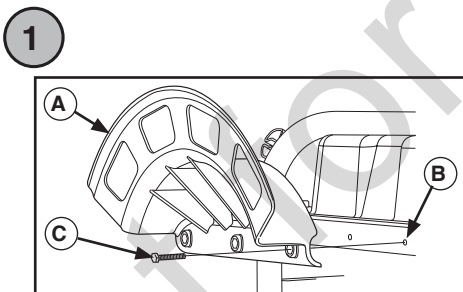

Attach accessory holders

All assembly instructions in this section will be viewing from engine end of unit.

1. Place hose wrap (A) over holes (B) on end of main unit. Using provided hex key wrench, attach hose wrap with three screws (C). Tighten by hand. 1
2. Insert spray gun holder wireform (D) through holes on right side of unit frame. Hold wireform in place and attach a plastic knob (E) from inside of unit. Tighten by hand. 2
3. Using provided hex key wrench, attach metal spring clips (F) to left side frame of unit with screws (G). Tighten by hand. 3

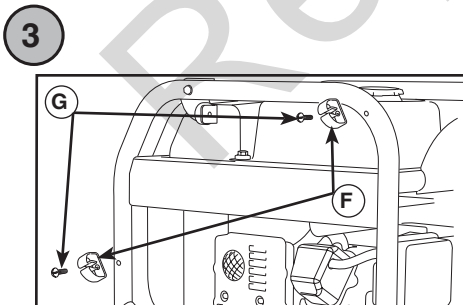
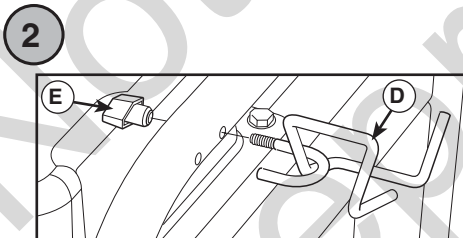

NOTICE Turn spring clips so that nozzle extension can be snapped in.

Install wheel kit

1. Lift corner of pressure washer and slide castor wheels up into bottom of tubing on each underside of pressure washer frame. 4
2. Using a 19 mm (3/4") wrench, turn nut (H) counterclockwise under collar of castor wheels to tighten. 4
3. Slide flat washer (J), wheel (K) and another flat washer (J) over axle stud (L). 5

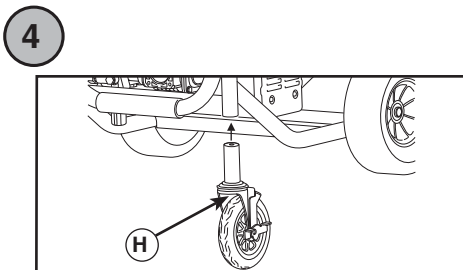

NOTICE Be sure to install wheel with raised hub inboard.

4. Lift corner of pressure washer slightly and slide axle stud through mounting bracket on pressure washer frame.
5. Insert retaining pin (M) through hole on axle stud. 5
6. Repeat steps 3 through 5 to secure second wheel.
7. Screw handle pin (N) into bracket on left side of frame. 6

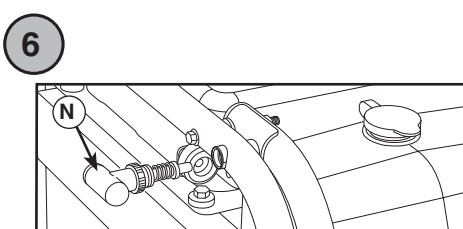
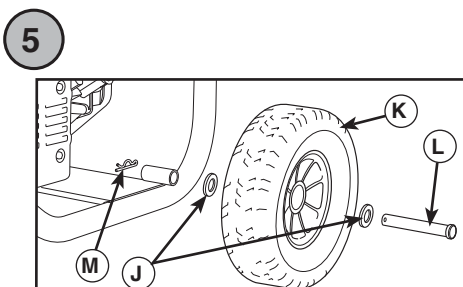

Attach negative battery cable

Your unit is equipped with electric start capability but can be started manually. If you choose not to use the electric start feature, you do not need to connect the negative battery cable. The sealed battery on the pressure washer is pre-installed except for the negative (black) battery cable.

WARNING Battery posts, terminals and related accessories contain lead and lead compounds - chemicals known to the State of California to cause cancer and reproductive harm. Wash hands after handling.

1. Cut off tie wrap securing loose end of negative (black) cable.
2. Using 8 mm wrenches, remove screw (P) and nut (Q) on negative battery terminal (-) (R). 7
3. Slide negative battery cable (S) over screw. 7
4. Reattach screw and nut on negative battery terminal and tighten.
5. Verify that connections to battery and pressure washer are tight and secure.

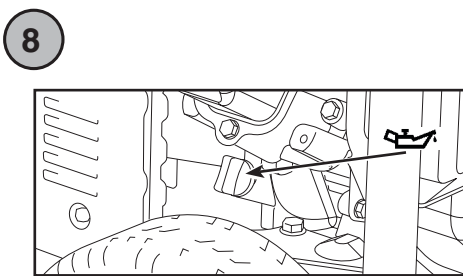
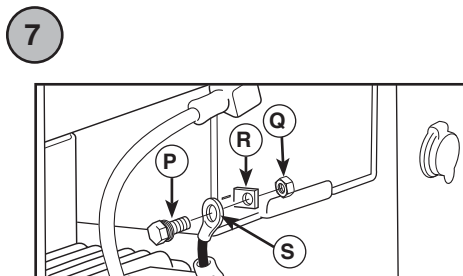

Add engine oil and fuel

NOTICE You MUST properly fill engine with oil before attempting to start pressure washer.

NOTICE DO NOT use unapproved gasoline such as E15 and E85. DO NOT mix oil in gasoline or modify engine to run on alternate fuels.

1. Move pressure washer outdoors to a flat, level surface.
2. Clean area around oil fill and remove oil fill cap (W). 8
3. Using oil funnel, slowly pour contents of supplied oil into oil fill opening to the point of overflowing at oil fill cap. DO NOT OVERFILL.
4. Replace oil fill cap and fully tighten.
5. Clean area around fuel cap (U), remove fuel cap. 9
6. Slowly add unleaded gasoline (T) to fuel tank (U). Be careful not to fill above the baffle (V). This allows adequate space for fuel expansion as shown. 10
7. Install fuel cap and let any spilled fuel evaporate before starting engine.

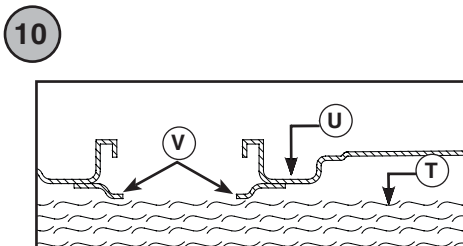
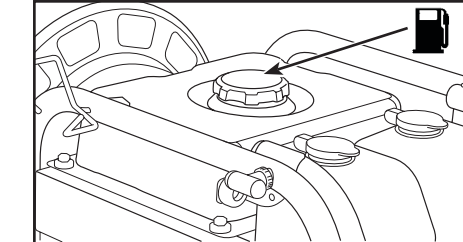

Move pressure washer to safe operating location

1. Move pressure washer outdoors to a flat, level surface. 11
2. Keep at least 5 ft. (1.5 m) clearance on all sides of pressure washer including overhead to reduce the risk of exhaust heat or exhaust gases igniting nearby combustible material.
3. Place lock levers on castor wheels in the ON (I) position to lock wheels and keep pressure washer from moving. 12

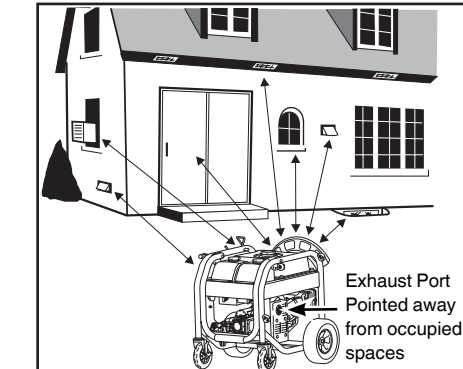

Connect spray gun

NOTICE Remove and discard the shipping caps from the pump's high pressure outlet and water inlet before attaching hoses.

1. Uncoil high pressure hose and attach quick connect end of hose (W) to base of spray gun (X). Pull down on collar of quick connect, slide onto spray gun and let go of collar. Tug on hose to be sure of tight connection. 13
2. Similarly, attach other end of high pressure hose to high pressure outlet (Y) on pump. Push back on collar of quick connect, slide onto pump and let go of collar. Pull on hose to be sure of tight connection. 14

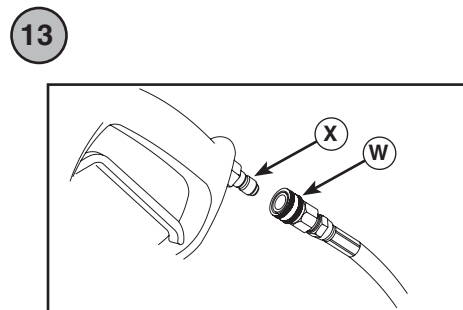
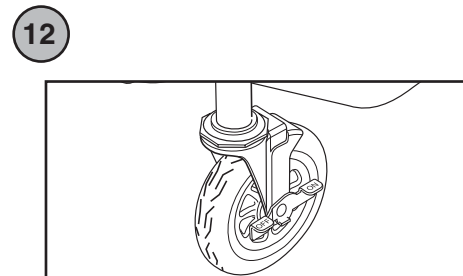

Connect water supply

1. Inspect garden hose inlet screen (Z) for damage. 15

NOTICE If inlet screen is damaged or missing, DO NOT use pressure washer, call **1-800-743-4115**.

2. Clean screen if necessary. Refer to operator's manual for instructions.
3. Run cold water through garden hose (aa) for 30 seconds to clean out any debris. Garden hose length must not exceed 50 ft. (15 m). Turn off water supply and attach garden hose to water inlet (bb). Tighten by hand. 15

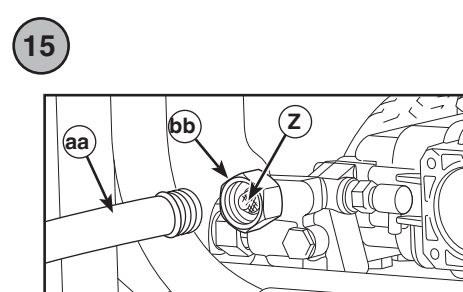
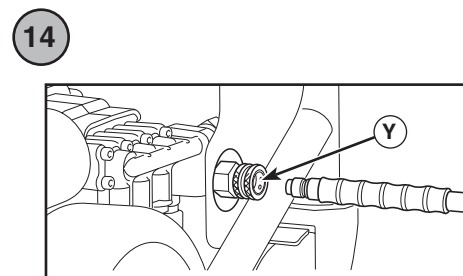

Start pressure washer

NOTICE You MUST connect and turn on water supply fully before starting engine.

1. Put on safety goggles.

WARNING Risk of eye injury. Spray could splash back or propel objects resulting in serious injury. Always wear indirect vented (chemical splash) safety goggles marked to comply with ANSI Z87.1 when using or in vicinity of this equipment. NEVER substitute safety glasses or dry-condition goggles for indirect vented safety goggles.

2. Turn on water supply.
3. Point spray gun in a safe direction, press the red safety button (cc) and squeeze trigger to purge pump system of air and impurities. **16**
4. Attach nozzle extension (dd) to spray gun (X). Tighten by hand. **17**
5. Pull back on collar of nozzle extension (dd), insert spray tip (ee) and release collar. Tug on spray tip to make sure it is securely in place. **18**
6. Rotate fuel shut-off valve (ff) to ON position. **19**
7. Move throttle lever (gg) to FAST (👉) position. **20**
8. Move choke lever (hh) to CHOKE position (⌘). **21**

16

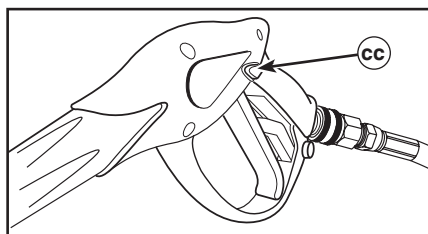

17

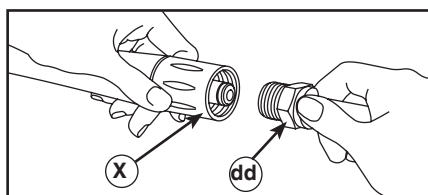

18

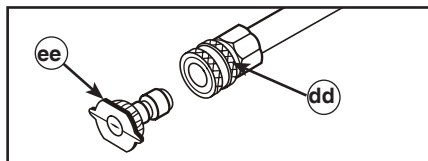

19

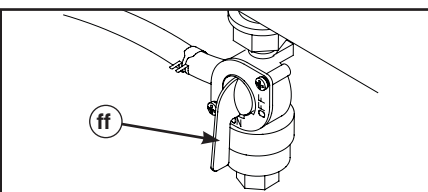

20

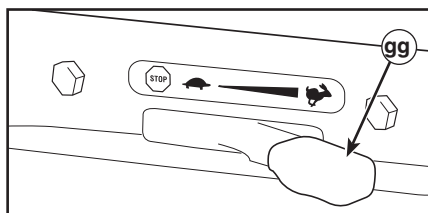

21

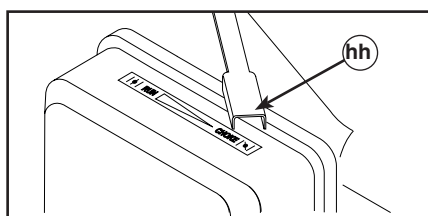

9. Start pressure washer using Electric or Manual starting:

For electric starting, turn and hold key (jj) in start switch to start position (Ⓢ) until pressure washer starts. To prolong the life of starter components, DO NOT hold key in start position (Ⓢ) for more than 15 seconds, and pause for at least 1 minute between starting attempts. **22**

For manual starting, position yourself as recommended, grasp recoil handle and pull slowly until slight resistance is felt. Then pull rapidly one time only to start engine. Return recoil starter slowly. DO NOT let rope "snap back" against starter. **23**

WARNING Starter cord kickback (rapid retraction) can result in bodily injury. NEVER pull starter cord without first relieving spray gun pressure. Pull starter cord slowly until resistance is felt, then pull rapidly. Kickback will pull hand and arm toward engine faster than you can let go. High pressure can cause spray gun to kickback. Hold spray gun with both hands during use.

NOTICE After each starting attempt, where engine fails to run, always point spray gun in a safe direction, push red button and squeeze spray gun trigger to release retained high water pressure.

10. When engine starts, slowly move choke lever (hh) to RUN position (Ⓡ), as engine warms. If engine falters, move choke lever to CHOKE position (⌘), then to RUN position (Ⓡ). **21**
11. If engine fails to start after six pulls, move choke lever to RUN position (Ⓡ), and repeat step 9.

NOTICE Always keep the throttle lever in the FAST (👉) position when operating the pressure washer.

12. Point gun toward surface to be cleaned. Press the red safety button and pull trigger to begin spraying.

Stop pressure washer

1. Release spray gun trigger and let engine idle for two minutes.
2. Move throttle lever (gg) to SLOW (👈) position, then STOP (⏹) position. **20**
3. Rotate fuel shut-off valve (ff) to OFF (0) position. **19**
4. Turn off water supply.
5. Always point spray gun in safe direction, press the red safety button, and squeeze spray gun trigger to relieve retained high water pressure.
6. Disconnect garden hose from pump.
7. Disconnect high pressure hose from pump and gun for storage. For long term storage instructions, see operator's manual.
8. Remove safety goggles.

22

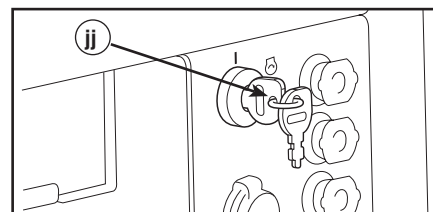

23

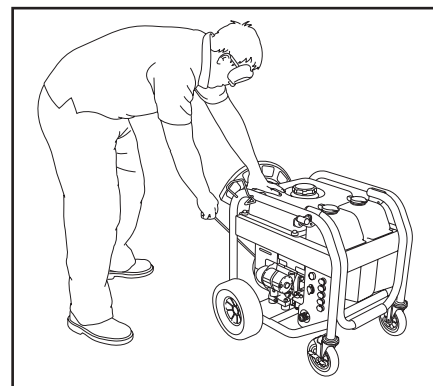

Not for
Reproduction